

RUBBER CRAWLER CARRIER

MOROOKA

MST- 300 to MST-1500
and

HITACHI

CG35-C

Operation & Maintenance Manual

WARNING

Unsafe use of this machine may cause serious injury or death. Operators and maintenance personnel must read this manual before operating or maintaining this machine. This manual should be kept with the machine for reference and periodically reviewed by all personnel who will come into contact with it.

FOREWORD

Thank you for purchasing this machine.

This manual describes procedures for operation, handling, lubrication, maintenance, checking, and adjustment. It will help the operator realize peak performance through effective, economical and safe machine operation.

- Please read this manual carefully BEFORE operating the machine.
- Please continue studying this manual until proper operation is completely reinforced into personal habit.
- ★ Operation, inspection, and maintenance should be carefully carried out, and the safety must be given the first priority. Safety precautions are indicated with  marks in this manual.

BREAKING IN YOUR NEW MACHINE

Each machine is carefully adjusted and tested before shipment. However, a new machine requires careful operation during the first 100 hours to break in the various parts.

If a machine is subjected to unreasonably hard use at the initial operation stage, the potential of performance will prematurely deteriorate and the service life will be reduced. A new machine must be operated with care, particularly with regard to the following items.

- After starting, let the engine idle for 5 minutes to allow proper engine warm-up prior to actual operation.
- Avoid operation with heavy loads or at high speeds.
- Sudden starting or acceleration, unnecessarily abrupt braking and sharp turning should be avoided.
- At the first 100 hours of operation, the machine should be maintained in the following manner:

- 1) Replacement of all oil, traveling motor and hydraulic oil.
- 2) Check and retighten the nuts and bolts.

(For replacement procedure, refer to EVERY 300 HOURS SERVICE, EVERY 500 HOURS SERVICE and EVERY 600 HOURS SERVICE).

- ★ When replacing oil filter elements (cartridges), check their interiors for dirt and dust. If heavily collected, check for possible cause before starting operation.

CONTENTS

OPERATION		MAINTENANCE	
SAFETY HINTS . . . ▲	4	PERIODIC MAINTENANCE	39
GENERAL LOCATIONS AND SPECIFICATIONS . . .	12	PRECAUTIONS FOR MAINTENANCE	40
OPERATOR'S COMPARTMENT	14	MAINTENANCE TABLE	43
INSTRUMENTS AND CONTROLS	16	INITIAL 25 HOURS SERVICE	45
CHECK BEFORE STARTING	23	EVERY 25 HOURS SERVICE	45
OPERATING YOUR MACHINE	25	INITIAL 100 HOURS SERVICE	46
TRANSPORTATION	31	EVERY 300 HOURS SERVICE	46
HANDLING OF BATTERY	32	EVERY 500 HOURS SERVICE	47
COLD WEATHER OPERATION	35	EVERY 600 HOURS SERVICE	48
		ADJUSTMENT	49
		TROUBLE SHOOTING GUIDE	52
		STORAGE	54
		FUEL, COOLANT AND LUBRICANTS	56

SAFETY HINTS • • • !

GENERAL

- Wear well-fitting hard hat, safety shoes and working clothes. Never wear loose or unbuttoned clothes as they may catch on protruding parts of machine. Never wear clothes covered in oil.
- Learn the prohibitions, precautions and rules about work procedures in the job site. Make every effort to prevent accidents by always following these and always bearing safety in mind.
- If there should be an accident or fire or any other such unexpected mishap, deal with it quickly, using the nearest apparatus. In addition, it is necessary to prevent any secondary mishaps. It is also important to know the emergency contact system.
- Do not overwork or drive after drinking. Take care of your health. Driving while unfit can lead to mistakes in judgement in emergencies.
- Learn beforehand the locations and method of use of emergency equipment such as first aid boxes, fire extinguishers or other fire-fighting equipment.
- Learn how to use the control devices, gauges and warning devices. Be sure you understand the meaning of the caution plates and other signs. Remember the check points and checking method for engine oil, fuel, cooling water and hydraulic oil levels. Always know the dimensions and capacity of your machine.
- Fuel, oil and anti-freeze are dangerous. Never smoke or light matches when handling fuel, oil, grease or anti-freeze. Do not handle these substances near any fire or flame. When selecting a place for storing them, take care to choose a place away from where fire is used.
- Exhaust gas is dangerous. When running the engine for long periods in a poorly ventilated area, there is a danger of gas poisoning, so open the windows or doors to ensure a good supply of fresh air.
- When operating inside a building always be sure of the clearances of the ceiling, entrances, aisles, etc. and the load limit of the floor.

BEFORE STARTING OPERATION

- Examine the lay of the land and the kind of soil at the site to determine the dangerous points and the best method of operation. Proceed with the work only after making safety arrangements about the dangerous points. Avoid operating near cliffs or deep gullies. Be particularly careful of the edge of cliffs, falling rocks or landslides.
- Always carry out inspection and maintenance correctly. Check for leakage of fuel, lubricant or hydraulic oil, and for loose, broken or missing parts.
- If there are any such problems always correct them. Never use the machine without correcting all problems.
- Use repaired machines only after receiving permission from the serviceman in charge of the repair.
- Adjust the operator's seat until it is in the most comfortable position for operating.
- When getting on or off the machine, use the handrail and step provided. Do not jump up or down from the machine.
- Learn about the safety devices on your own machine and about how to use them. Confirm that they are correctly attached in the prescribed position.
- Before starting the engine, confirm that all control levers are in "NEUTRAL".
- To ensure the safety of workers near the machine, always signal or sound the horn to warn them before starting the engine, moving the machine or turning.
- Be particularly careful to check that the rear is clear before backing the machine.
- Do not leave parts or tools lying around in the vicinity of or on the floor of the operator's compartment. Keep everything in its proper place, to avoid any hindrance while driving.
- Wipe off thoroughly any grease, oil or mud on the step, handrail, floor or control levers. Failure to do this may cause you to slip.
- Check the level of the fuel, lubricants and cooling water. Do not smoke or use naked flames when checking. Extinguish cigarettes before checking or refilling. Check that the radiator cap and all oil filler caps or plugs are firmly tightened.
- When there is a leader, fix standard signals and always follow these signals when operating. Learn the signs and rules used in the job site and always follow them.
- Inspect inside of the engine room and remove any dead leaves or paper. Dead leaves or paper are highly inflammable and can cause fires.

DURING OPERATION

- Before starting operations, start the engine and do the following.
 - Check that all gauges are working properly
 - Check the play and travel of each lever and pedal
 - Operate the work equipment and check that it is working properly
 - Drive the machine slowly in a safe place and turn the machine to the left and right to check that the steering system is working properly.
 - Check that the exhaust gas color is normal
 - Check that there is no abnormal noise or vibration
- When operating, work slowly and carefully. Do not rush your work. Fast operation may look efficient, but it is dangerous and leads to breakdowns. So in the long run it is not efficient.
- The work area should always be kept flat. This increases operating efficiency and makes driving smooth.
- When driving, sit in the operator's seat correctly so that the truck can be operated properly.

During while not sitting in the operator's seat, or driving while standing are dangerous.
- Do not travel with the door opened.
- Always concentrate. It is extremely dangerous to allow yourself to be distracted or to think of other things when operating a machine. Always pay attention to your driving, and to your surroundings. In dangerous places, or where there is restricted visibility, it is important to get down from the machine and confirm whether it is safe before continuing work.
- When stopping at junctions, to avoid collisions with other vehicles, keep your distance and confirm who has priority.
- Be careful of those around you, and always confirm that there is no person or obstacle in the way before driving or turning machine.
- When traveling down hill, adjust the speed with the travel lever and fuel control lever.

AFTER OPERATION

- The machine condition can be judged from many factors. Changes in the gauges, sound, vibration, exhaust gas color or response of the control levers can indicate the occurrence of some disorder. If any disorder occurs, park the machine immediately in a safe place and take appropriate action. Be especially careful in the case of fuel leaks as there is danger of fire.
- Do not allow unauthorized persons to enter the work area.
- Always consider the weight of the machine when driving on roads in snow or rain, or on muddy or soft terrain. Be careful to avoid the tires slipping or sinking into the ground.
- When towing a broken-down machine, first check that the brakes are working properly, then connect the machine with a suitable tow-rope or cable. When towing on roads, always follow traffic regulations and attach a correct warning sign.
- The machine should always be operated at a speed where it can be correctly controlled. The following are dangerous.
 - ★ **Speeding**
 - ★ **Snaking**
 - ★ **Coasting**
- Never leave the operator's seat without switching the engine off.
- Before crossing bridges, confirm that the bridge is strong enough to take the weight of the dump truck.
- When continuing operations after rain, remember that conditions may have changed from those before the rain, so proceed with caution. Be particularly careful when approaching the shoulder of the road or cliffs, as they may have been loosened by the rain.
- When parking the machine, park it in a safe place outside the working area, or in the specified place. The following factors should be considered when choosing a parking place: It should be on flat, firm ground where there is no danger of rockfalls, landslides or floods.
- When the machine has to be parked on a slope, chocks must always be placed under the tracks.

When operating on uneven ground or in places where there are obstacles, remember the following points:

- When operating on uneven ground, drive at as low a speed as possible and avoid sudden changes in direction.
- Wherever possible, avoid travelling over large rocks, fallen trees, tree stumps and other such obstacles. Either use the working equipment to remove them, or travel round them.

When operating at the edge of a cliff or on the shoulder of a road, remember the following points:

- When operating in a place where there is danger of the machine falling over the side, be doubly careful. Do not approach the edge of the cliff or road shoulder by mistake.
- When working on river embankments or other places made of piled soil, there is the danger that the weight or vibration of the machine may cause the machine to sink into the piled soil, so be extremely careful when operating in such places.

- When driving at the side of a road where there is danger of the ground collapsing, use the tracks left by previous machines. If the ground starts to sink, stop and reverse out immediately. It is important to check the strength of the road shoulder before driving on it.

When operating on slopes, remember the following points:

- When driving on a slope, always drive directly up or down it. Never drive horizontally or diagonally across the slope, as this may cause the machine to roll over or slip sideways.
- When going down a slope, use the engine as a brake. If this is not enough to control the speed of the machine, use the steering brake as well.
- As far as possible, avoid turning the machine on a slope. It may cause the machine to roll over or slip sideways.

- Do not mount wooden or iron plate, fallen trees or logs. Piles of leaves or branches are also very slippery, so proceed with caution.
 - Before going up or down a slope, select a travel speed most suited to the slope.
- When operating in water or in muddy areas, remember the following points.
- When operating in water or when crossing shallows, first check the bed soil condition and the depth and flow speed of water, then proceed, taking care not to go beyond the permitted depth.
 - If the machine gets stuck in mud, it is completely useless to increase the engine speed, causing the tracks to spin, or to rock the machine backwards and forwards. In such a case, reduce the load if possible, and drive out slowly.
 - When passing through a narrow space, be careful of the side and overhead clearances. Take special care not to touch any obstacles on either side or overhead. If necessary, have someone outside the machine call.
- When working near electric cables, move the cables if possible. If this is difficult, erect barriers around the cables to prevent electric shock, or insulate the cables and observe the following precautions.
 - ★ Always remember there is a danger of electric shock, so never touch the electric cables.
 - ★ Always wear shoes with rubber or leather soles.
 - ★ Appoint a special supervisor to ensure adequate supervision.
 - ★ Standing too near electric cables may cause electric shocks from sparks. The following table shows the minimum safe distances for different voltages. Do not go closer than these distances.

Voltage (No. of insulators)	Standard min. safe distance
6.6 KV (Wires only)	3m
33.0 KV (1 – 3)	4m
66.0 KV (5 – 8)	5m
154.0 KV (10 – 18)	8m
275.0 KV (16 – 30)	10m

- ★ Learn action to be taken in case of electric shock.

When operating at night, remember the following points:

- Be sure to arrange an adequate lightening system.
- At night it is very easy to make mistakes in assuming the distance and height of objects and land.
- When operating in fog, mist or smoke, where visibility is bad, be especially careful to confirm first whether operation is safe.

When visibility drops below safety level, stop work and wait for the visibility to improve.

When operating in snow, or cleaning snow, remember the following points:

- Even slight slopes can cause unexpected side slipping, so in such places, operate with extreme caution.
- Take care not to overload the dump body. Overloading shortens the service life of the truck.

When backing to dump a load, be careful not to back too far. Place blocks or build a small ridge to stop the tracks at the dumping point.

- Never drive with the dump body raised. Always lower the body before moving.

● **Loading**

Be sure to load the dump truck evenly.

MEMO

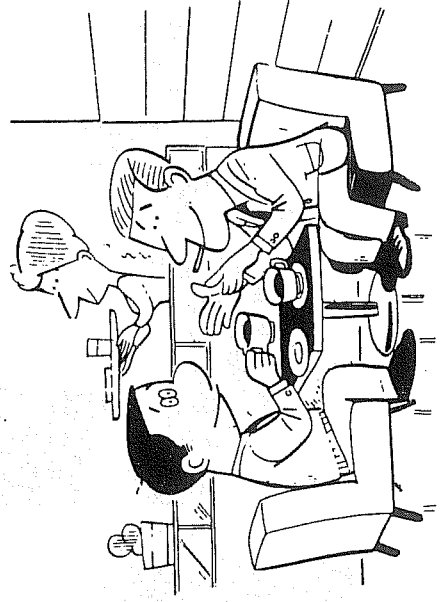

GENERAL LOCATIONS AND SPECIFICATIONS

- 1. Track frame
- 2. Track rubber

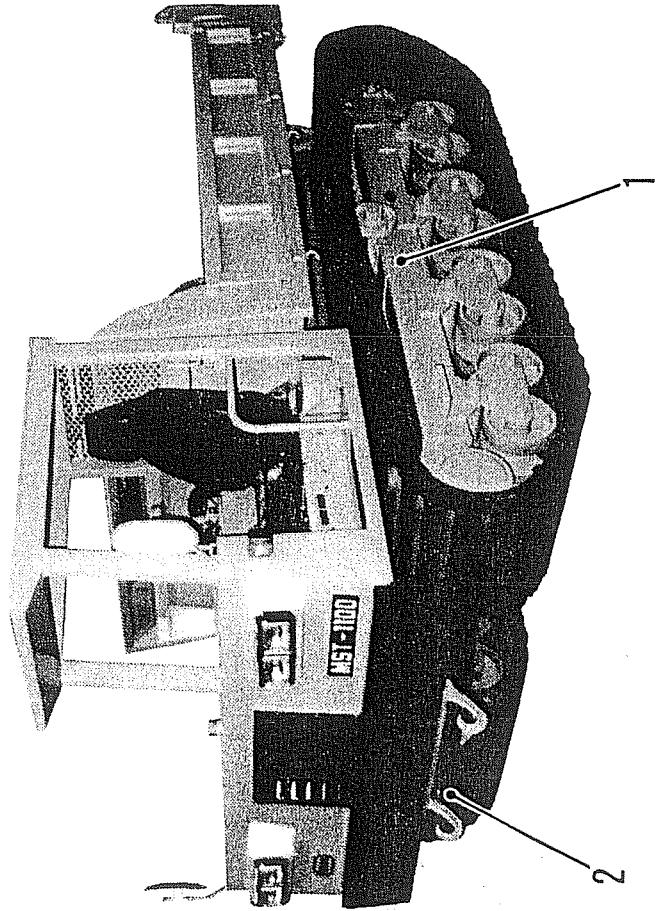

MACHINE MODEL	
OPERATING WEIGHT (kg)	
TRAVEL SPEED (Km/h)	
DUMP BODY CAPACITY	STUCK (m ³)
	HEAPED (m ³)
ENGINE MODEL	
FLYWHEEL HORSEPOWER	rpm
	HP

MST-300	MST-500	MST-600	MST-800	MST-1100	MST-1500
3000	3890	3900	5740	6300	7500
Max. 10	Max. 11	Max. 12	Max. 13	Max. 10	Max. 12
0.8	1.2	1.3	1.8	2.1	2.4
1.3	1.8	2.0	2.7	3.1	3.5
Mitsubishi 4DQ5	Komatsu 4D95L-1	Mitsubishi 4D31	Mitsubishi 4D31T	Komatsu S6D95L-1	Mitsubishi 6D14CT
3000	2500	2800	3000	2500	2800
45	70	75	100	133	160

OPERATOR'S COMPARTMENT

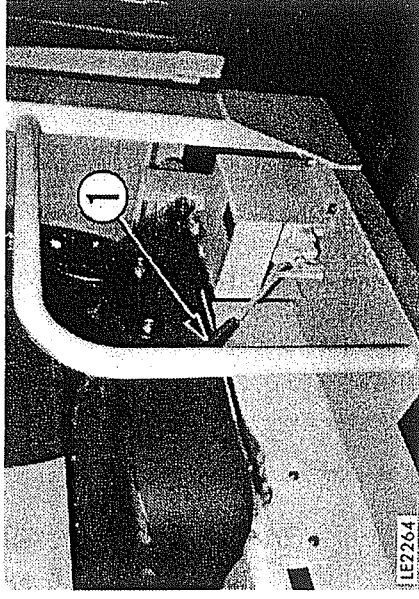

(MST-300, 600, 800, 1500)

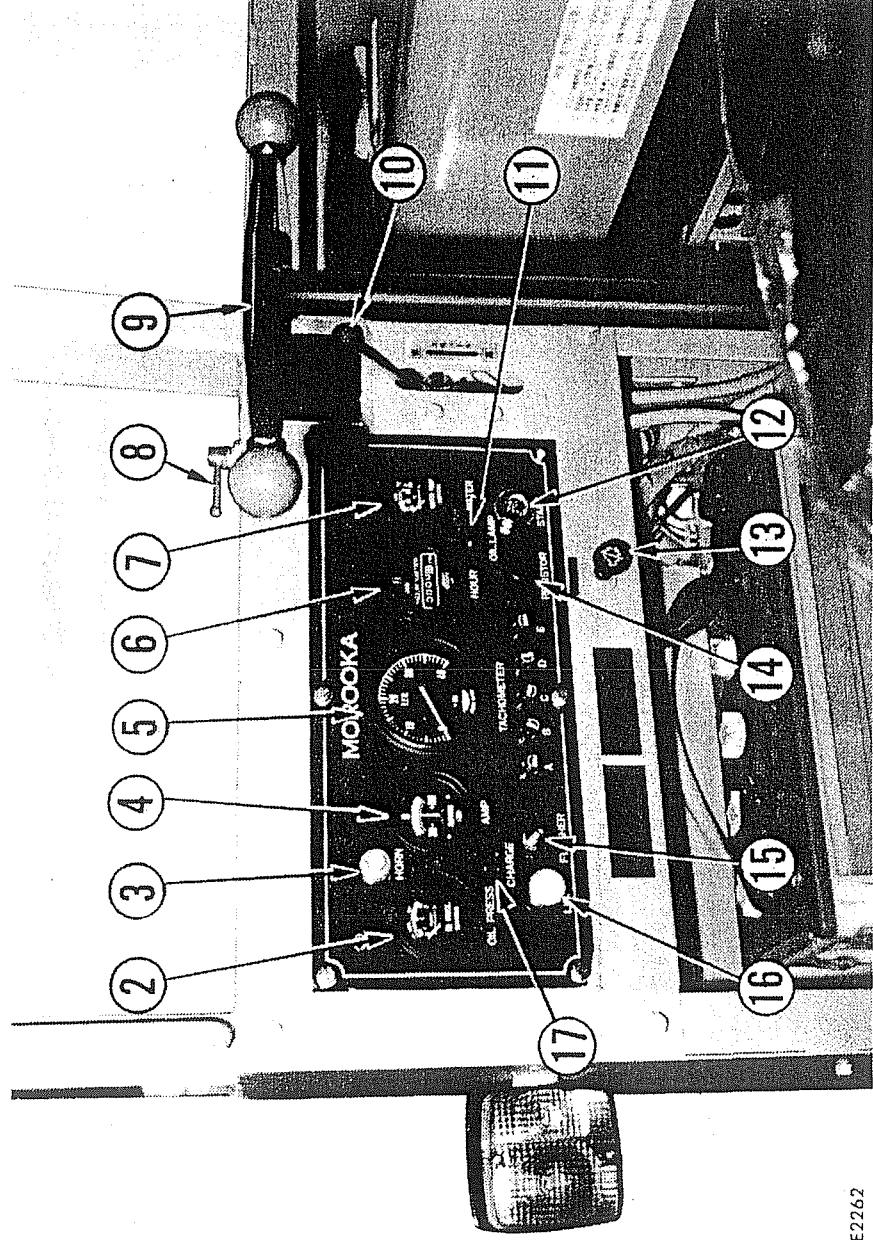

1. Dump lever
2. Engine oil pressure gauge
3. Horn switch
4. Ammeter
5. Tachometer
6. Service meter
7. Engine water temperature gauge
8. Parking lever
9. Traveling and steering lever
10. Fuel control lever
11. Engine oil pressure warning lamp
12. Starting switch
13. Engine stop lever
14. Resistor
15. Flasher lever
16. Lamp switch
17. Charge lamp

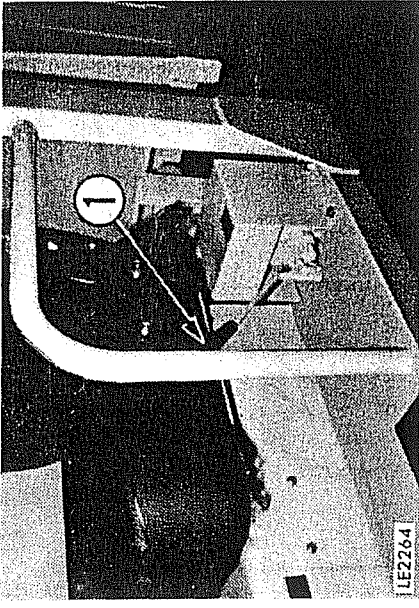

1. Dump lever
2. Engine oil pressure gauge
3. Horn switch
4. Ammeter
5. Tachometer
6. Engine water temperature gauge
7. Parking lever
8. Traveling and steering lever
9. Fuel control lever
10. Engine oil pressure warning lamp
11. Engine stop lever
12. Starting switch
13. Resistor
14. Flasher lever
15. Lamp switch
16. Charge lamp

(MST-500, 1100)

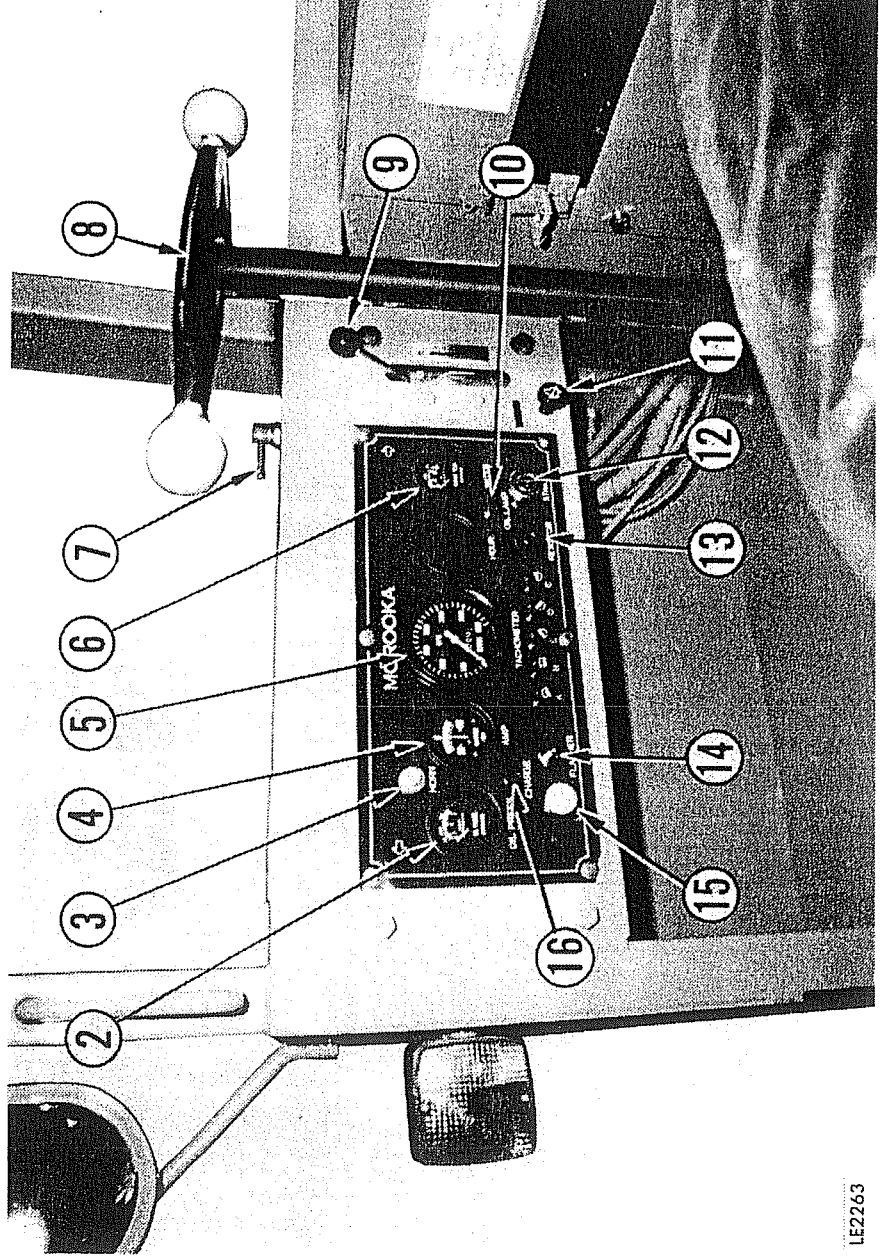

LE2263

INSTRUMENTS AND CONTROLS

STARTING SWITCH

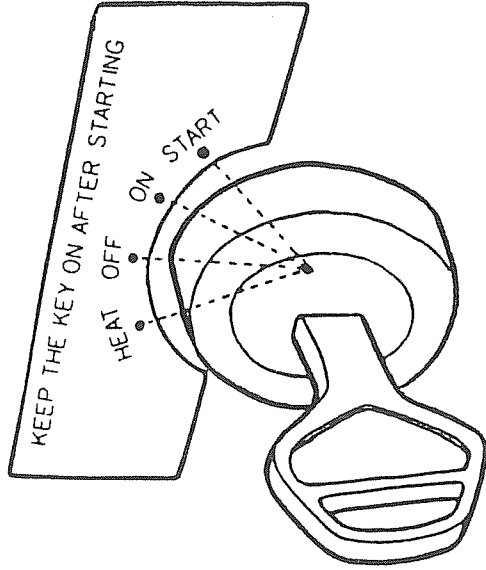

ON

Charging and lamp circuits activate.
Keep key at ON after starting.

HEAT

Use this position when starting in cold weather.

Release the key to allow it to return automatically to OFF and then, without delay, turn it to START.

★ When starting, be sure to use the starting key.

OFF

Key insertion-withdrawal position.
None of electrical circuits activate.

START

At this key position, the starting motor will crank the engine. Release key immediately after starting.

ENGINE WATER TEMPERATURE GAUGE

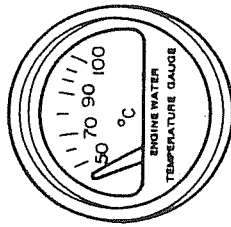

This shows the temperature of the engine cooling water.

It should indicate 75 to 85°C during normal operation.

If the indicator goes above 100°C during operation, cut the load and run the engine at low idling until the temperature drops.

ENGINE OIL PRESSURE GAUGE

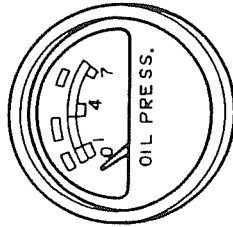

When the indicator is in the green range during operation, engine oil pressure is normal.

When the indicator moves outside the green range, run the engine at low idling speed until the engine oil pressure goes down.

AMMETER

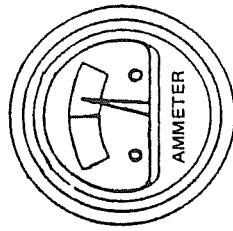

The center range indicate the battery is being charged; the red range indicates the battery is being discharged.

When the indicator comes to the red range, check the cause.

TACHOMETER

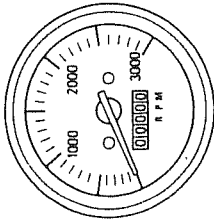

This shows the revolutions per minute of the engine.

(MST-500, 1100)

The built-in service meter is in this meter.

RESISTOR

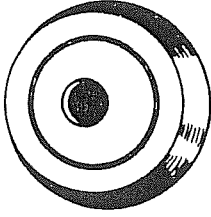

This signal is red-heated after the starting switch is turned to HEAT, thus indicating the electrical intake air heater is heated.

LAMP SWITCH

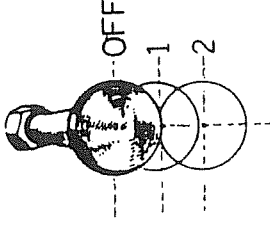

The head lamps light by moving the lighting switch knob as shown.

Position 1: Head lamps at high beam

Position 2: Head lamps at low beam

HORN SWITCH

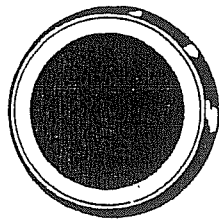

Push the button to sound the horn.

ENGINE OIL PRESSURE WARNING LAMP



It is normal that the lamp does not light during machine operation.

Lighting of the lamp during operation indicates a low engine oil pressure. Stop the engine immediately and check for engine oil pressure.

TRAVELING AND STEERING LEVER

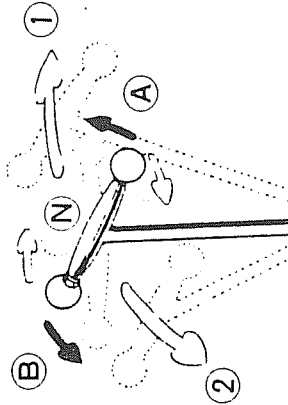

The traveling and steering lever is used to operate the left and right travel motors.

① Forward:

Push the lever forward.

② Reverse:

Pull the lever backward.

Ⓐ Left pivot turn (forward)

Ⓑ Right pivot turn (forward)

Ⓐ Neutral:

Parking brake is applied and the machine stops.

FLASHER LEVER

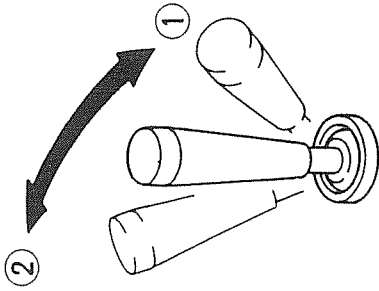

This lever operates the turn signal lamps.

- ① RIGHT TURN
- ② LEFT TURN

FUEL CONTROL LEVER

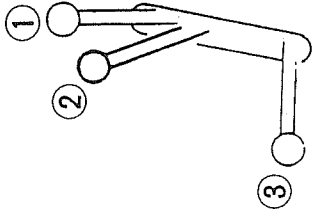

This lever is used to control the engine speed and output.

- ① Engine stop position:
Push the lever fully.
- ② Low idling position:
Pull the lever from engine stop position ① until you feel the operating force falls off.
- ③ High idling position:
Pull the lever fully from low idling position ②.

ENGINE STOP LEVER

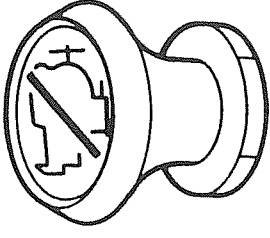

Pull the lever to stop the engine.
Push it to return it to the operating position.

PARKING LEVER

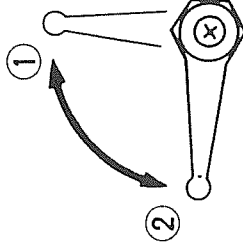

This lever operate the parking brake.

- ① PARKING
- ② RUNNING

DUMP LEVER

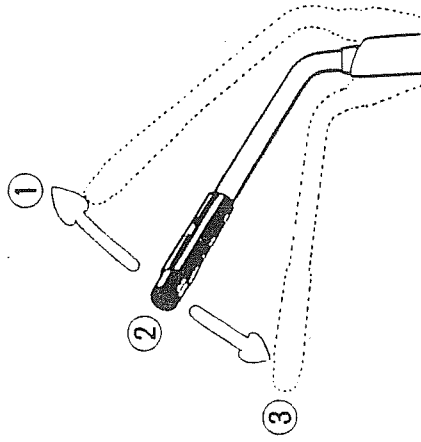

The dump lever is provided to shift the dump body position.

Lever position:

- ① RAISE
- ② HOLD

The dump body is kept held where it is.

- ③ LOWER

DUMP BODY

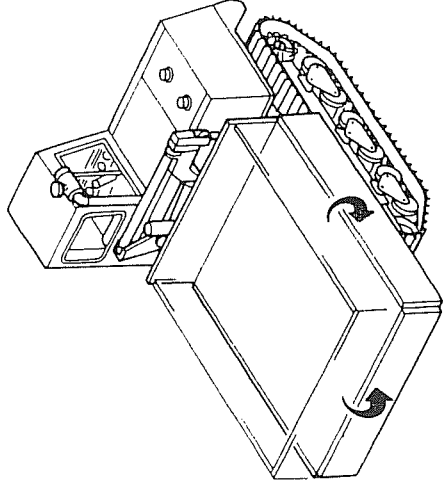

The rear flap of the dump body automatically opens when the dump body is raised, and is automatically locked when the dump body is lowered, so there is no need to open or close it by hand.

The side flaps of the dump body can be opened by setting the hook in the FREE position. This enables the dump body to be opened in three directions.

FUSE

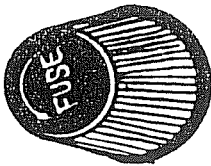

Fuses serve to protect electrical parts and wiring from getting burnt out because of excessive current. If white powder appears on the fuse surface because of corrosion, replace the fuse.

When replacing a fuse, remove the cover by turning it in the direction of the arrow.

⚠ Before replacing a fuse, be sure to disconnect the electrical system from the power source or place the starting switch key in OFF.

Terminal mark	Fuse capacity	Circuit
A	15A	Wiper, Room lamp, turn signal lamp
B	15A	Engine oil pressure warning lamp
C	15A	Charging lamp, Engine water temperature gauge
D	15A	Horn, Head lamp
E	40A	Ammeter

CHECK BEFORE STARTING

Pre-operation checks forestall machine trouble. Never neglect them.

a. Walk around the machine and check for any trace of oil or water leakage. Examine connections of high pressure hoses, hydraulic cylinders, final drive and radiator with special attention.

If any leakage is evident, check for the cause and repair.

b. Check tightness of bolts and nuts, and retighten if required. Particular checks are required for mounting of air cleaner and muffler.

c. Check for broken electric wirings, short circuits and loose terminals.

d. CHECK AND REFILL COOLANT

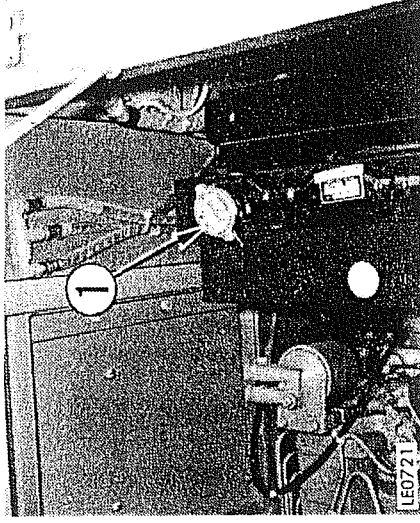

Remove radiator cap (1) and check that the coolant level is in the shaded area. If level is low, add water. If more water than normal is required to fill up to the specified level, coolant is considered to be leaking somewhere. Immediately locate the leak and plug it.

! Do not remove cap (1) while cooling water is hot. Hot water may spout out.

When removing cap (1), turn it slowly to relieve inner pressure.

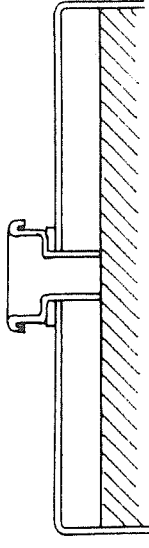

e. CHECK DUST INDICATOR

When air cleaner element is clogged, the red piston of dust indicator (1) reaches service level and gets locked. In the case, clean element.

After cleaning element, push the button to return red piston.

CHECK BEFORE STARTING

f. CHECK FUEL LEVEL

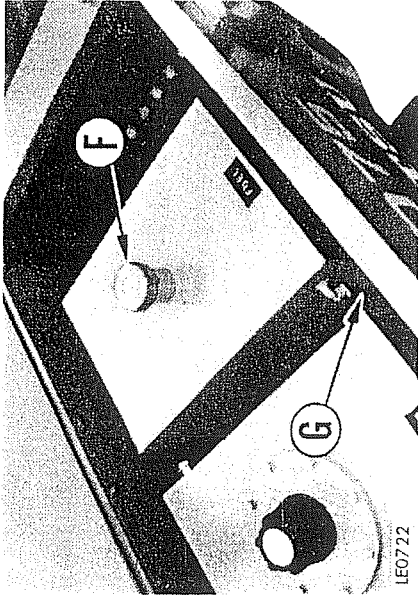

1. Check the fuel level using sight gauge (G) on the side face of the tank.
2. Upon completion of work, pour in additional fuel from filler (F) until the fuel tank is full.

★ Refer to the section "FUEL, COOLANT AND LUBRICANT".

g. CHECK OIL LEVEL IN ENGINE OIL PAN

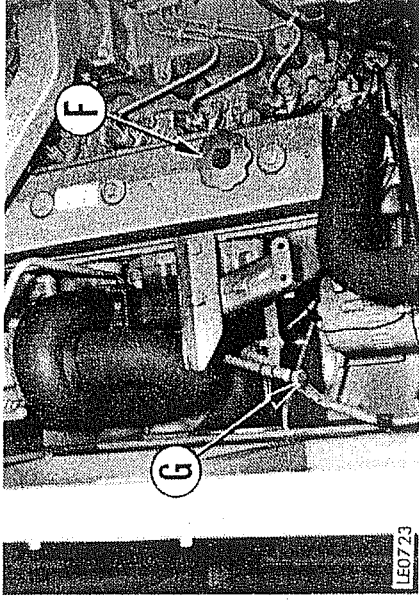

1. Use the dipstick (G) to check the oil level.
2. The oil level should be between mark L and H, if necessary, add oil at the oil filler (F).

★ Stop the engine when checking the oil level.

★ Make an oil level check before starting engine or 15 minutes or more after the engine is stopped. If oil remains at various portions of the engine, the correct oil level cannot be measured.

h. CHECK TRAVELING MOTOR AND TRANSMISSION PUMP FOR NOISE

i. CHECK TRACK TENSION

OPERATING YOUR MACHINE

BEFORE STARTING

Perform pre-operation checks referring to the section **CHECK BEFORE STARTING**.

TO START THE ENGINE

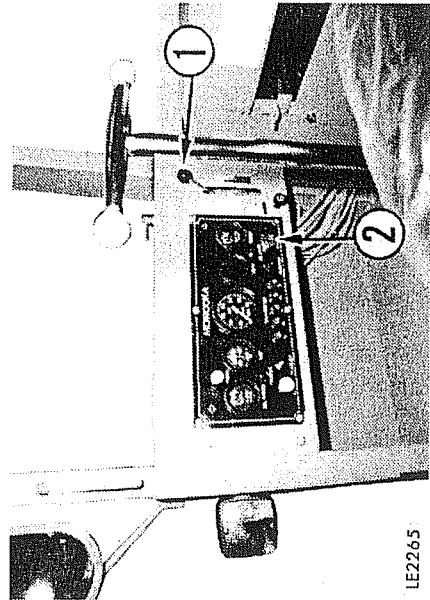

2. Turn starting key (2) to the **START** position.

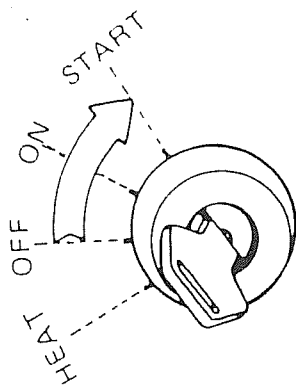

1. Pull fuel control lever (1) a little towards you from the low idling position.

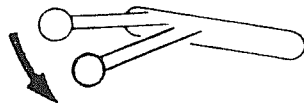

3. When engine is started, release starting key (2) and the key will return automatically to **ON**.

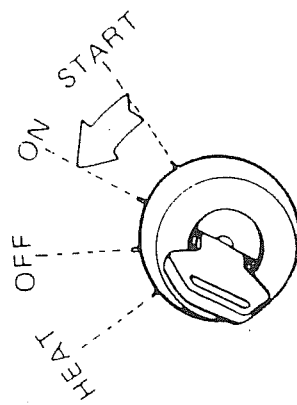

CHECKS AFTER STARTING

After starting, make the following checks.

- ★ If engine will not start, repeat the starting procedure after about 2 minutes.
 - ★ Do not leave the key in START for more than 20 seconds.
 - ★ Do not put the key in OFF position while the engine is running.
 - ★ To start the engine in cold weather, refer to **COLD WEATHER OPERATION**.
2. After warm-up run is completed, check gauges and caution lamps for proper operation.
 3. Check if the exhaust color is normal or whether there is any abnormal noise or vibration.
 - ★ Avoid abruptly accelerating the engine until the completion of warm-up.

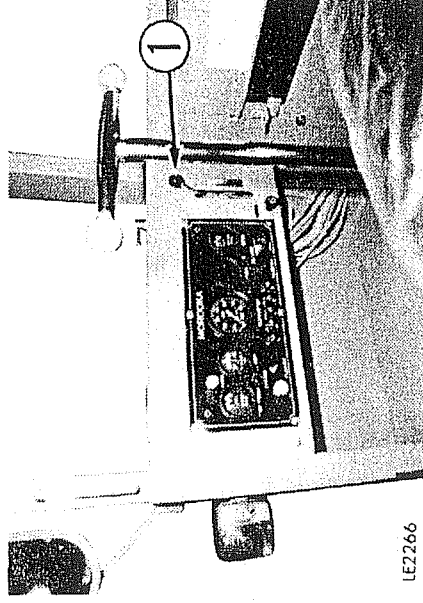

1. Pull fuel control lever (1) and run the engine at medium speed. Then run the engine at no load for about 5 minutes.



STOPPING THE ENGINE

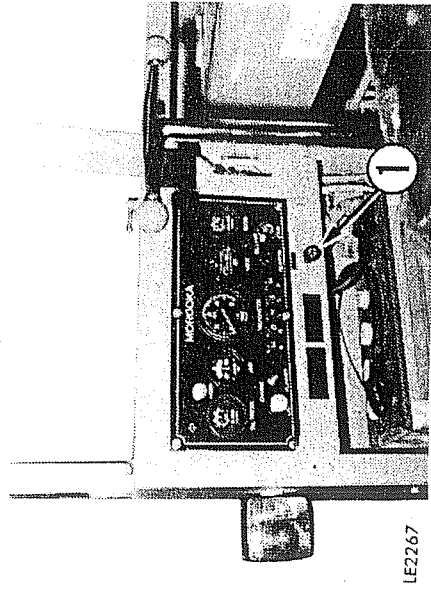

1. Cool the engine by running it at low idling speed for about 5 minutes.

- ★ If engine is stopped abruptly before it cools down, engine life may be greatly shortened.
Never stop engine abruptly except in case of emergency.
- ★ Especially when the engine is overheated, allow the engine to idle without immediate stoppage so that the engine is gradually cooled down to be ready for proper stoppage.

2. Pull the engine stop lever (1) to stop the engine.

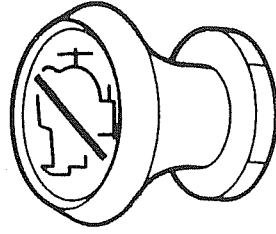

TO MOVE THE MACHINE OFF

Before starting the machine, confirm the safety around the machine, and make a signal.

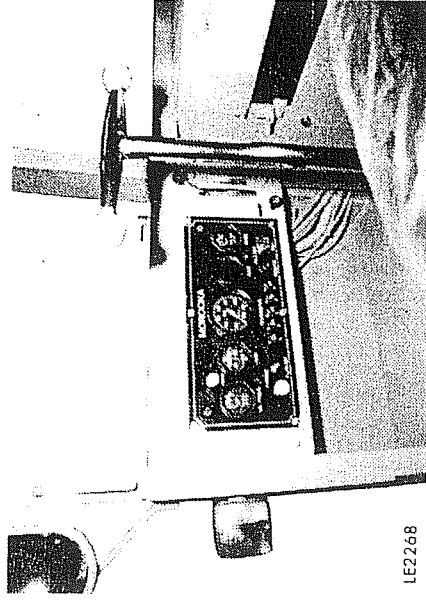

1. Bring the work equipment in the traveling posture.
2. Pull fuel control lever to increase engine speed.

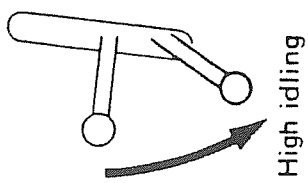

3. Slowly incline traveling and steering lever in the forward or reverse direction, and move off.

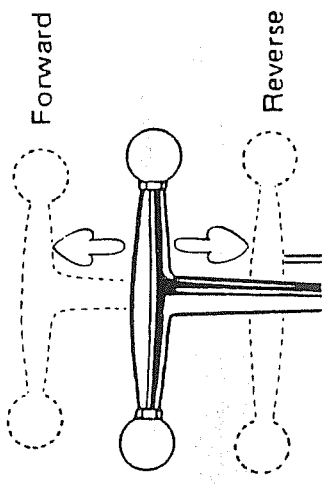

CHANGING DIRECTION

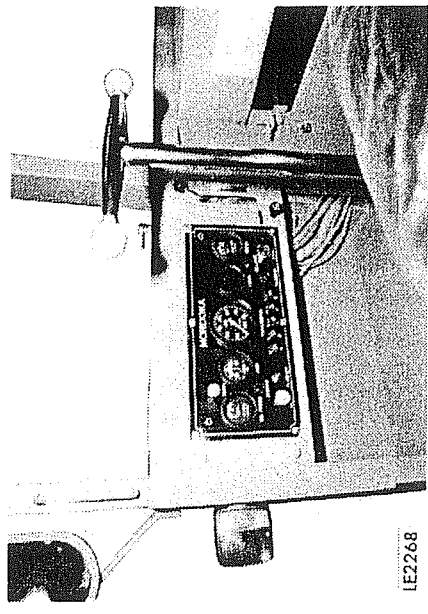

LE2268

Operate the traveling and steering lever in the following manner.

⚠ Avoid abruptly operating the traveling and steering lever with the fuel control lever fully open, as this will cause the machine to move off suddenly.

TO STOP THE MACHINE

- When changing the direction of a running machine

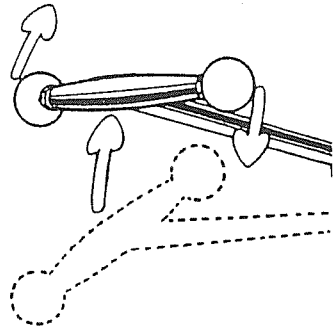

When making a left turn, incline the traveling and steering lever forward. Then incline the lever to the left.

- ★ In the case of a right turn, incline the traveling and steering lever to the right in a similar manner to the above.

- When performing counterrotation

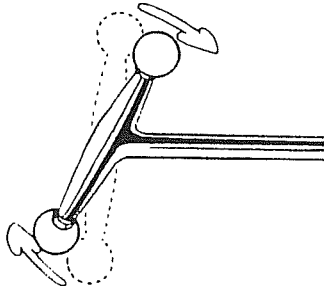

To counterrotate the machine to the left, incline the traveling and steering lever to the left.

- ★ In the case of a right turn, incline the traveling and steering lever to the right.
- ★ Avoid abruptly changing the direction of the machine as far as possible. In particular, before counterrotating the machine, first bring it to a halt.

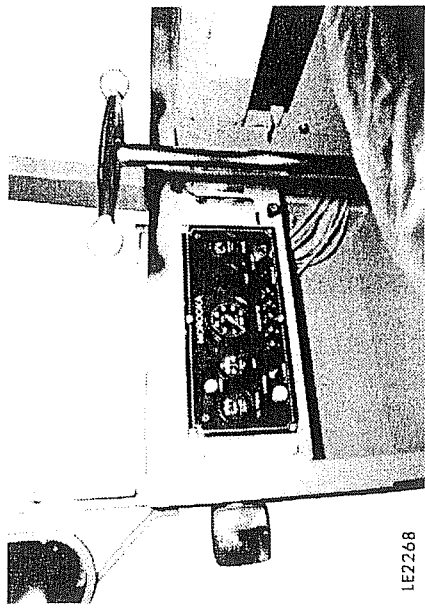

LE2268

OPERATING YOUR MACHINE

1. Put the traveling and steering lever in the neutral position.

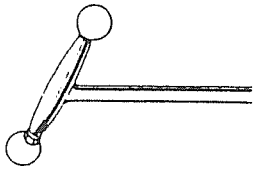

2. Lower the engine speed using fuel control elver.

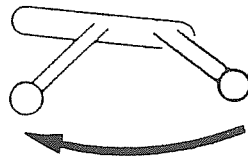

High idling

- ★ To stop the engine refer to STOPPING THE ENGINE.

! When stopping the machine, select flat hard ground and avoid dangerous places. If it is unavoidable, insert blocks underneath track rubbers.

TRANSPORTATION

When transporting the machine, observe the various road rules, road transportation vehicle laws and vehicle limit ordinances, etc. It is a good idea to obtain a special platform for loading and unloading the machine. When it is unavoidably necessary to use ramps, however, at the least observe the following for safety.

1. Properly apply the brakes on the trailer and insert blocks beneath the tires to ensure that it does not move. Then fix the ramps in line with the centers of the trailer and the machine.
 - ★ Make sure the ramps have sufficient width, length and thickness to enable the machine to be safely loaded and unloaded.
 - If the ramps sag appreciably, reinforce it with blocks, etc.
2. Determine the direction of the ramps, then slowly load or unload the machine.
 - ▲ **Never change travel direction on the ramps. When changing direction, back up off the ramps and change direction on ground.**
3. Load machine at a suitable place on trailer. To prevent machine from moving during transportation, hold it securely in place by applying blocks to front and rear of track rubber and by fastening machine with chain or wire rope. Secure machine with special care to prevent shifting sideways.
4. Keep various control lever in the following place :
 - Fuel control lever in Engine low idling position
 - Take off the starting key.
 - ★ Determine the route for transporting the machine by taking into account the width, height and weight of the machine.



When loading the machine, park the trailer on a flat firm roadbed. Keep a fairly long distance between the road shoulder and the machine.

HANDLING OF BATTERY

PRECAUTIONS FOR CHARGING BATTERY

1. Before charging, disconnect the cable from the negative (-) terminal of the battery. Otherwise, an unusually high voltage will damage the alternator.
2. While charging the battery, remove all battery plugs for satisfactory ventilation.

To avoid gas explosions, do not bring fire or sparks near the battery.

3. If the electrolyte temperature exceeds 45°C, stop charging for a while.
4. Turn off the charger as soon as the battery is charged.

Overcharging the battery may cause followings:

- 1) Overheating the battery
- 2) Decreasing the quantity of electrolyte.
- 3) Damaging the electrode plate

5. If the electrolyte gets on your skin or clothes, immediately wash with plenty of clean water.

6. Do not mix up cables (positive (+) to negative (-) or negative (-) to positive (+)), as it will damage the alternator.

7. When inspecting or servicing a battery, be sure to stop the engine and turn the starting switch to "OFF" position.

8. When performing any service to battery besides checking the electrolyte level or measuring the specific gravity, disconnect cables from the battery.

REMOVAL AND INSTALLATION OF BATTERY

- When removing battery, first disconnect the cable from the ground (normally, from the negative (-) terminal). If a tool touches a cable connecting the positive terminal and the chassis, there is danger of sparks being emitted.
- When installing battery, the ground cable should be connected to the ground terminal as the last step.

STARTING ENGINE WITH A BOOSTER CABLE

When starting up the engine with a booster cable, do as follows:

- 1) Before connecting the booster cable
 - 1) Size of booster cable and clip should be suitable for the battery size.
 - 2) Check cables and clips for breaks, corroded surfaces, etc.
 - 3) Make sure cables and clips are firmly secured.
 - 4) Keep the starting switch in "OFF" position.
 - 5) The battery of the running engine must be the same capacity as that of engine to be started.

2. Connect the booster cables in the following manner.

- 1) Connect one clip of booster cable A to the positive (+) terminal of the engine to be started.
 - 2) Connect the other clip to the positive (+) terminal to the engine which is running.
 - 3) Connect one clip of booster cable B to the negative (-) terminal of the engine which is running.
 - 4) Connect the other clip to the body of the machine to be started.
 - ★ Make sure the clips are firmly connected to battery terminals.
- Then, start the engine.

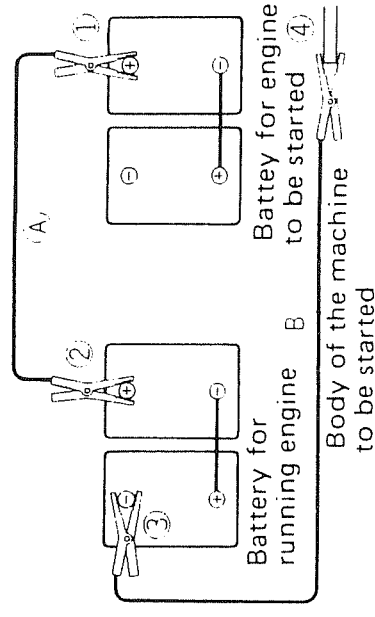

⚠ When connecting the cables, never contact the positive (+) and negative (–) terminals.

⚠ Make sure that the booster cable connections are correct. Connect the booster cable to the body as far as possible from the battery.

3. Starting the engine

- 1) Turn the starting switch to START position and start up the engine.
- 2) If the engine doesn't start at first, try again after 2 minutes or so.

After the engine has started, the booster cables should be disconnected in the reverse order in which they were connected.

1. Disconnecting the booster cables
 - 1) Disconnect the clip of booster cable B from the body of the machine which was started.
 - 2) Disconnect the other clip from the negative (–) terminal of the running engine.

- 3) Disconnect the clip of booster cable A from the positive (+) terminal of the running engine.
- 4) Disconnect the other clip from the positive (+) terminal of the engine which was started.

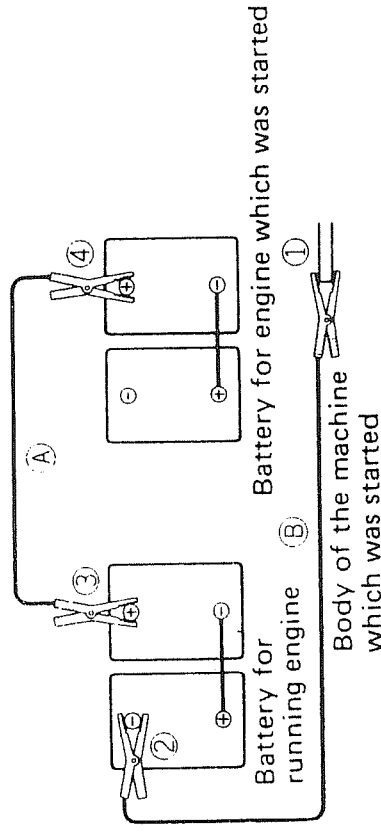

COLD WEATHER OPERATION

PREPARATION FOR LOW TEMPERATURE

- Replace lubrication oil by that with prescribed viscosity.
- Fuel of low pour point shall be used. ASTM D975 No. 1 diesel fuel should be used at atmospheric temperature lower than -10°C .

- Add antifreeze in the cooling water. When the atmospheric temperature drops lower than 0°C while the machine is stopped, prevent freezing by adding antifreeze to the cooling water. The mixing rate of antifreeze is determined according to the expected minimum temperature. The following table shall be used.

- ★ Cautions for using antifreeze
 - 1) Permanent type antifreeze shall be used.
 - 2) Soft water (ex: city water) shall be used as mixing water.
 - 3) Cooling systems must be thoroughly flushed before filling with antifreeze mixture.
 - 4) When the climate becomes warmer and antifreeze (except permanent type) is not needed, replace with soft water (ex: City water) after perfectly cleaning the cooling system.

Mixing rate of water and antifreeze

Min. atmospheric temperature ($^{\circ}\text{C}$)	-5	-10	-15	-20	-25
Antifreeze (%)	23	30	36	41	46



Take care for fire as antifreeze is inflammable.

Care in using antifreeze

Use a Permanent Antifreeze (ethylene glycol mixed with corrosion inhibitor, antifoam agent, etc.) meeting the standard requirements as shown below. With permanent antifreeze, no change of coolant is required for a year. If it is doubtful that an available antifreeze meets the standard requirements, ask the supplier of that antifreeze for information.

Standard requirements for permanent antifreeze

• SAE J1034

• FEDERAL STANDARD

. O-A-548D

★ Never use any antifreeze made from methyl alcohol or ethyl alcohol which may be a cause of engine trouble.

★ Where no permanent antifreeze is available, an ethylene glycol antifreeze without corrosion inhibitor may be used only for the cold season. In this case, coolant must be changed two times a year (at the beginning and at the end of the cold season).

★ Do not mix an antifreeze with one of different brand.

★ Absolutely avoid using any water leak preventing agent irrespective of whether it is used independently or mixed with an antifreeze.

● Battery
As ambient temperature drops, battery capacity will drop, and electrolyte may sometimes freeze if battery charge is low. Maintain battery at a charge level of approx. 100% and insulate it against cold temperature so that machine can be readily started the next morning.

★ Measure specific gravity of fluid and obtain rate of charge from the following conversion table:

Rate of charge	Temp. of fluid		
	20°C	0°C	-10°C
100%	1.28	1.29	1.30
90%	1.26	1.27	1.28
80%	1.24	1.25	1.26
75%	1.23	1.24	1.25

★ When electrolyte level is low, add distilled water in the morning before work instead of after the day's work. This is to prevent fluid from freezing at night.

CAUTIONS AFTER COMPLETION OF WORK

1. Mud and water on the machine body should be completely removed.

Park the machine on concrete or hard ground. If this is impossible, park the machine on wooden boards. This will prevent the accessories from freezing to the ground thereby preventing machine movement the next morning. Particular attention should be given to water drops collected on the surface of the hydraulic cylinder position rods.

Such droplets must be fully wiped off because if water is frozen to the rod when the cylinder is utilized, the cylinder oil seals may be damaged.

AFTER COLD WEATHER

When weather becomes warm, perform the following without fail:

- Replace lubricating oils for various units with the ones specified for warm-weather use.
- Drain antifreeze coolant (except permanent type), flush the inside of cooling system completely, and fill with clean soft water (such as city water).

2. Drain water collected in fuel system so that such water may be frozen at night.

3. As battery capacity drops at low ambient temperature, cover the battery or remove it from the machine to be kept warm at night.

MEMO

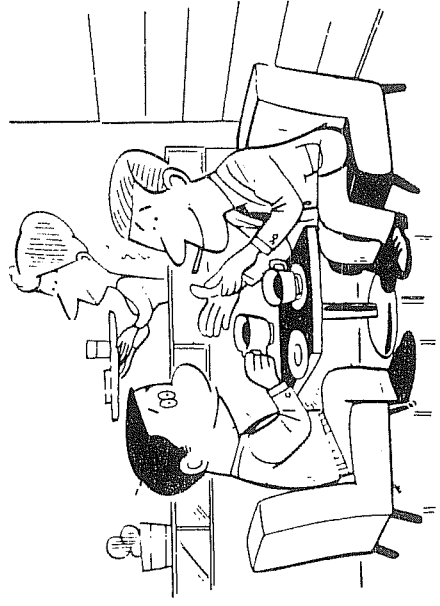

PERIODIC MAINTENANCE

Proper lubrication and maintenance assure trouble-free operation and long machine life. Time and money spent for scheduled periodic maintenance will be amply compensated by prolonged machine operation and reduced operating cost.

All hourly figures given in the following descriptions are based on service meter readings. In practice, however, it is recommended to rearrange all of them into units of days, weeks and months to make the maintenance schedule more convenient. Under rough job site or operating conditions, it is necessary to somewhat shorten the maintenance intervals stated in this manual.

For details of handling and maintenance of the engine and related parts, see the engine operation manual.

PRECAUTIONS FOR MAINTENANCE

For safety when carrying out maintenance.

Even simple operations, if carried out carelessly, can be the cause of injuries. At least the following points should be followed, but safety should always be borne in mind when carrying out any operation.

- Wear a well-fitting hard hat, safety shoes and working clothes. If the nature of the work so requires, wear protective goggles, gloves or other protection.

Never wear loose or unbuttoned clothes as they may catch on protruding parts of the machine. Never wear clothes covered in oil.

- Unless you have special instructions to the contrary, maintenance should always be carried out with the engine stopped. If maintenance is carried out with the engine running, there must be two men present: one sitting in the operator's seat and the other one performing the maintenance. Both should confirm the operation is safe.

- When working with others, choose a group leader, decide the work procedure and work according to the leader's instructions. Check with the others before doing anything. Do not move any part without warning and do not perform any maintenance beyond the agreed work.

- The body should always be lowered before carrying out any maintenance. However, if the nature of the maintenance requires the dump body to be raised for inspection or maintenance.
- Always stop the engine before washing the machine or charging oil.
- Never handle fuel, oil, grease or oily clothes in places where there is any fire or flame. As preparation in case of fire, always know the location and directions for use of fire extinguishers and other fire-fighting equipment.

- **Flames should never be used instead of lamps.** Never use a naked flame to check leaks or the level of oil, fuel, anti-freeze or electrolyte.
- Never smoke or bring naked flames near the battery. Never test the charge condition by striking the terminal with metal. Before servicing or charging the battery, always stop the engine, switch everything off and remove the vent caps. Before connecting or disconnecting the charger to the battery, always switch the charger OFF.
- When working on top of the machine, be careful not to lose your balance and fall. Arrange things beforehand so that no one starts the engine or moves the machine by mistake.
- Never inspect the fan belt or attempt any maintenance when the engine is running. Always stop the engine before carrying out maintenance on this or other moving parts, or near any moving parts.
- Always remember that the hydraulic oil circuit is under pressure. When filling or draining the oil tank or carrying out inspection and maintenance, release the pressure first.
- When carrying out maintenance, pay careful attention to persons in the vicinity. In particular, do not allow anyone to approach the machine unnecessarily.
- When leaning over to inspect cases, there is a risk of dropping things in. Before removing the covers to inspect such cases, empty everything from your pockets. Be particularly careful to remove wrenches and nuts.
- Immediately remove any oil or grease on the floor of the operator's compartment, or on the handrail. It is very dangerous if someone slips on floor plates.
- Always pay careful attention to those around you, particularly when using grinders, welding equipment or hammers.
- Exhaust gas is dangerous. When working inside, be particularly careful to have good ventilation.
- Special gauges are needed for checking hydraulic pressure. Performing these checks or other difficult maintenance carelessly may cause accidents.
- Do not handle electrical equipment while wearing wet clothes or gloves, or when standing in wet places. This may cause electric shock.

PRECAUTIONS FOR MAINTENANCE

GENERAL POINTS TO BE BORNE IN MIND WHEN CARRYING OUT MAINTENANCE

- Thoroughly wash the machine. In particular, be careful to clean the filler caps, grease fittings and the area around the dipsticks. Be careful not to let any dirt or dust into the system.
- Always use pure oil or grease, and be sure to use clean containers, to prevent any dirt from getting in.
- When checking or changing the oil, do it in a place free of dust, and prevent any dirt from getting into the oil.
- Before draining the oil, warm it up to a temperature of 30 to 40°C.
- Be particularly careful when removing the radiator cap or the hydraulic oil tank filler cap.
- After replacing or cleaning the oil, filter element or strainer, bleed the air from the circuit.
- When the strainer is located in the oil filler, the strainer must not be removed while adding oil.
- There should be neither too much nor too little lubricant. When adding oil or checking the oil level, check that the oil is at the correct level.
- After greasing up, always wipe off the old grease that was forced out.
- When changing the oil or filter, check the drained oil and filter for any signs of excessive metal particles or other foreign materials.
- When removing parts containing O-rings, gaskets or seals, clean the mounting surface and replace with new sealing parts.
- Special measuring apparatus is needed for testing hydraulic pressure. When carrying out other difficult maintenance work, carrying them out carelessly can cause unexpected accidents.

MAINTENANCE TABLE

No.	ITEM	SERVICE	PAGE
CHECK BEFORE STARTING			
a	Oil and water leak	Check	23
b	Nuts and bolts	Check and retighten	23
c	Electric wiring	Check and retighten	23
d	Coolant	Check and supply	23
e	Dust indicator	Check	23
f	Fuel	Check and supply	24
g	Engine oil pan	Check and supply	24
h	Traveling motor and transmission pump	Check noise	24
i	Track rubber	Check tension	24
INITIAL 25 HOURS SERVICE			
a	Line filter	Replace	45

No.	ITEM	SERVICE	PAGE
EVERY 25 HOURS SERVICE			
a	Lubricating		45
b	Transmission pump	Check	45
c	Track rubber	Adjust	45
d	Control valve	Check noise	45
e	Friction parts	Clean	45
INITIAL 100 HOURS SERVICE			
a	Traveling motor	Change oil	46
b	Hydraulic tank	Change oil	46
c	Nuts and bolts	Check and retighten	46
EVERY 300 HOURS SERVICE			
a	Hydraulic tank	Check oil level and supply	46
b	Traveling motor	Check oil level and supply	46

INITIAL 25 HOURS SERVICE

Perform the following maintenance after running the machine for the first 25 hours.

a. LINE FILTER

For details of method of replacing, see the section on EVERY 500 HOURS SERVICE.

INITIAL 25 HOURS SERVICE
EVERY 25 HOURS SERVICE

EVERY 25 HOURS SERVICE

a. LUBRICATING

Apply grease to the grease fittings.

b. CHECK TRANSMISSION PUMP

c. ADJUST TRACK RUBBER

d. CHECK CONTROL VALVE FOR NOISE

e. CLEAN THE FRICTION PARTS

INITIAL 100 HOURS SERVICE
EVERY 300 HOURS SERVICE

INITIAL 100 HOURS SERVICE

Perform the following maintenance after running the machine for the first 100 hours.

- a. TRAVELING MOTOR, CHANGE OIL
- b. HYDRAULIC TANK, CHANGE OIL
- c. NUTS AND BOLTS, RETIGHTEN

For details of the method of replacing, see the section on EVERY 500 HOURS and 600 HOURS SERVICE.

EVERY 300 HOURS SERVICE

- a. HYDRAULIC TANK

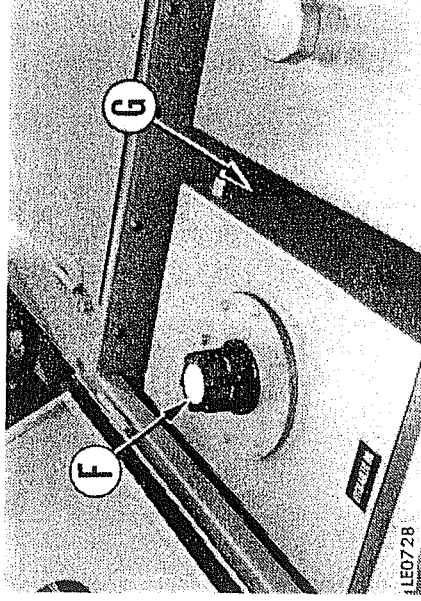

Stop the engine and wait for about 5 minutes before checking oil level.

If the level of hydraulic oil is not between top H and bottom L Lines of sight gauge (G), pour in additional hydraulic oil from filler (F).

★ Maintenance for every 25 hours should be carried out the same time.

- b. TRAVELING MOTOR

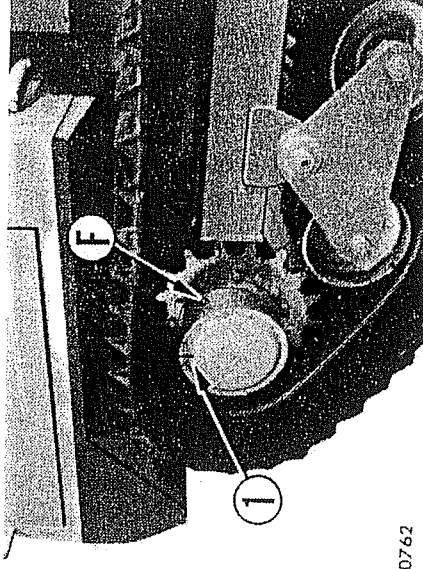

1. Park the machine holding the arrow mark (1) upward.
2. Remove plug (F) and check that the oil level is near the bottom of the plug hole.
If necessary, add gear oil through the plug hole.

EVERY 500 HOURS SERVICE

★ Maintenance for every 25 hours should be carried out at the same time.

(Only MST-300)

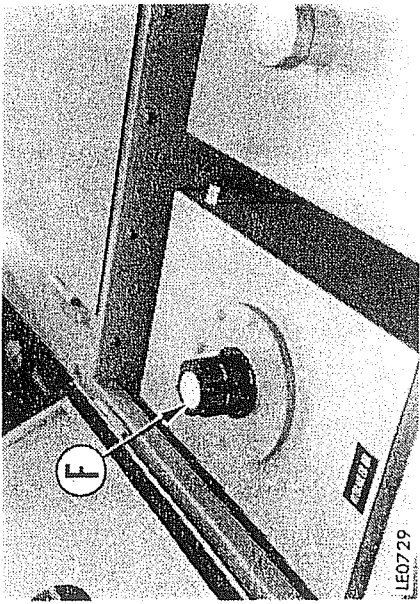

1. Remove cap (F).

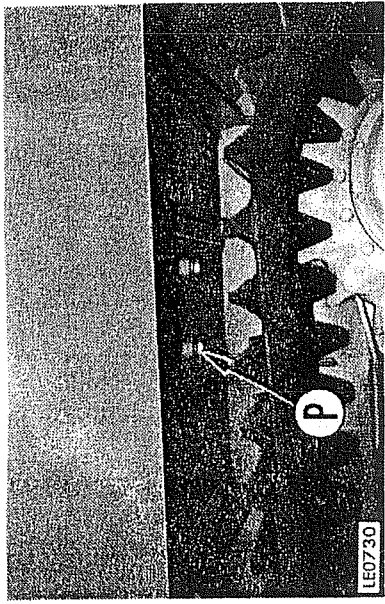

2. Drain off oil from drain plug (P) at the bottom of the tank. After draining, tighten the drain plug (P).

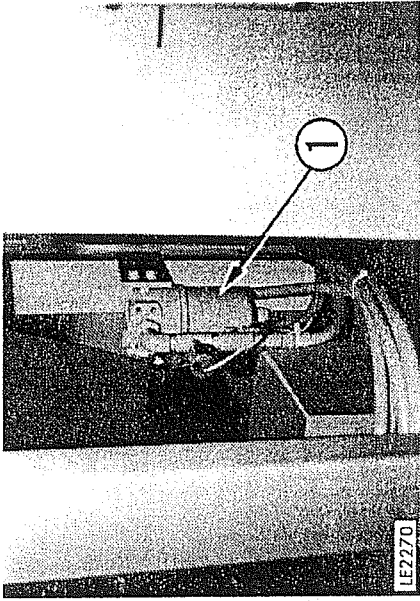

3. Remove the filter case (1).

4. Replace the line filter. Install the filter case (1).

5. After replacing the filter, pour in the specified quantity of hydraulic oil from oil filler (F).

★ Refer to the section "FUEL, COOLANT AND LUBRICANT".

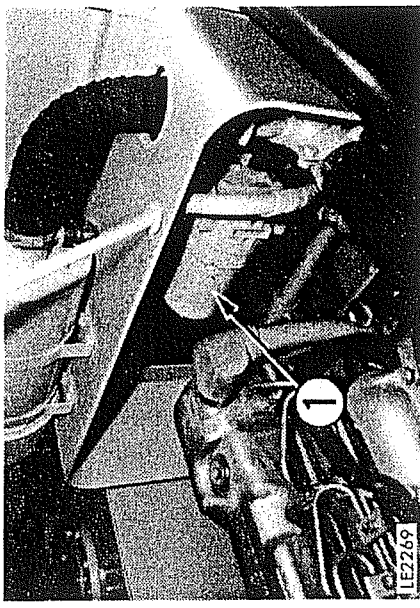

EVERY 600 HOURS SERVICE

a. TRAVELING MOTOR

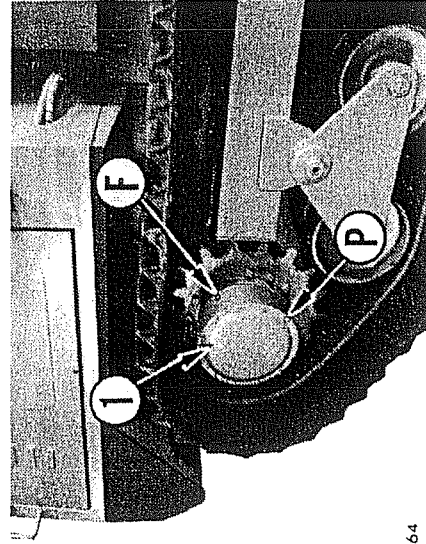

LE07 64

1. Park the machine holding the arrow mark (1) upward.
2. Drain the oil from drain plugs (P) on both sides of the machine. After draining, tighten the drain plugs.
3. Then, supply new gear oil through oil filler (F) respectively to the specified level.

★ Maintenance for every 25 and 300 hours should be carried out at the same time.

ADJUSTMENT

TRACK RUBBER

When it is first used, the track rubber stretches to settle the rubber and the core. If this stretching causes the track rubber to come off, install it and adjust it as follows.

1. Put jacks in contact with the front and rear of the frame, and raise the track rollers off the ground on the side where the track rubber has come off.

★ When doing this, put a support under the frame to hold the chassis in position securely.

2. Remove the grease nipple cover, then loosen the pressure release bolt until the grease comes out to reduce the internal pressure.

3. Remove the nipple, and let the grease out from inside the cylinder.

4. Push the holder in towards the front of the machine.

! Do not remove the grease nipple suddenly. It may fly off, so this is extremely dangerous.

5. Fit the track rubber on the front sprocket first, then fit the rear part on the rear idler.

! The track rubber is extremely heavy so be careful when handling it.

6. Rotate the sprocket and push the track rubber.

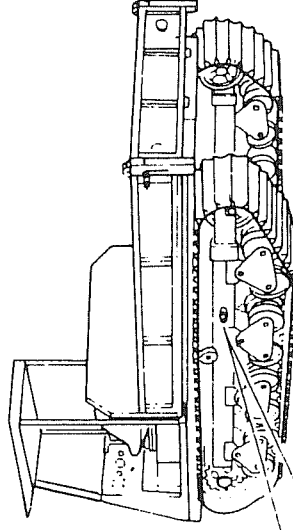
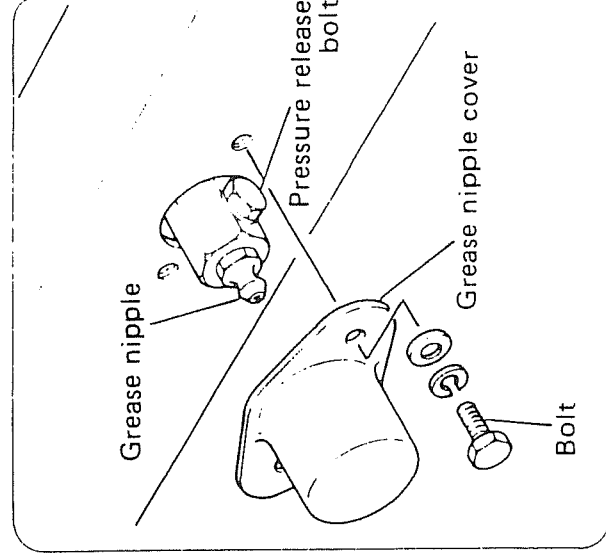

ADJUSTMENT

- Put a steel pipe in contact with the protruding part on the inside of the track rubber, then rotate the sprocket again.

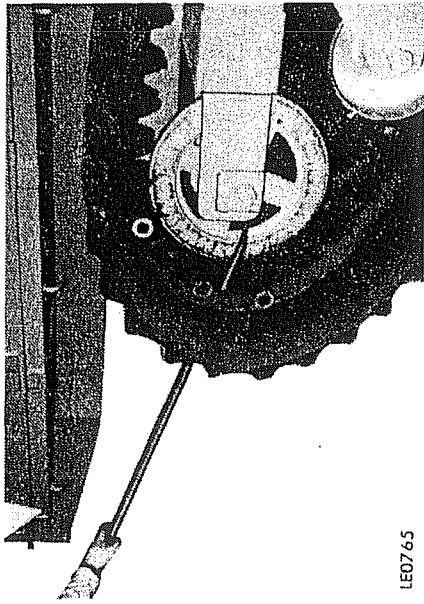

LED765

- ★ Always rotate the sprocket in the direction shown by the arrow in the diagram below.

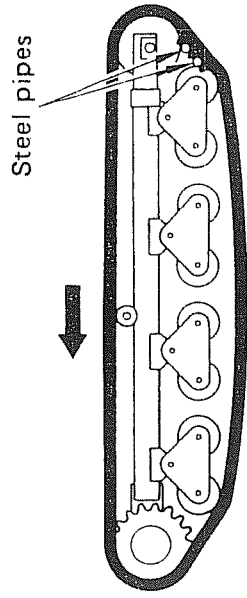

- Check that the track rubber is meshed securely with the sprocket and idler.
- Tighten the nipple and pressure release bolt securely.
- Pump in grease through the nipple with a grease pump, and adjust so that the distance from the rear of the track frame to the center of the rear idler is dimension A (See the table of the next page).
- Install the grease cover.
- Check that the tension of the track rubber and the meshing with the sprocket and rollers is correct, then lower the machine to the ground.

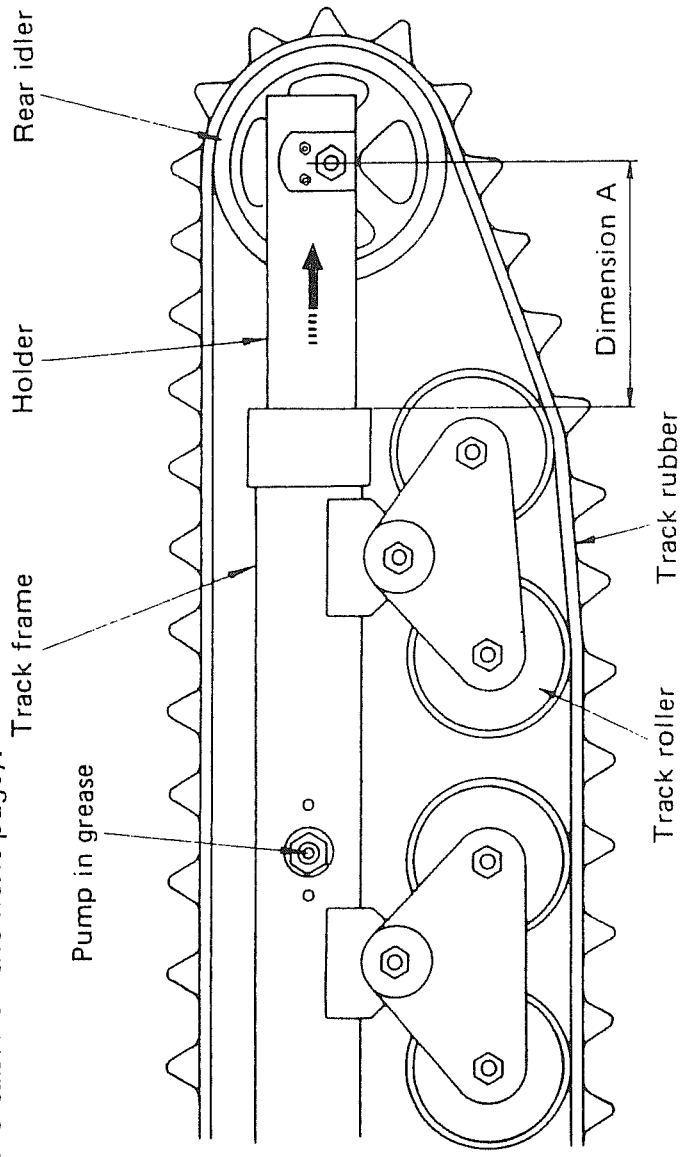

Table of dimension A

Machine model	Standard Value (mm)
MST-300	200 ± 5
MST-500	290 ± 5
MST-600	215 ± 5
MST-800	315 ± 5
MST-1100	305 ± 5
MST-1500	440 ± 5

TROUBLE SHOOTING GUIDE

ENGINE

Oil pressure caution lamp lights even when engine speed is increased after warm-up run.

- Oil level in oil pan low (drawing air).
- Oil filter element clogged.
- Oil leaks due to insufficient tightening or damage of oil pipe or pipe joint.

Steam is emitted from top of radiator (from valve).

Indicator on engine water gauge is in abnormal range.

- Cooling water insufficient or leaks.
- Fan belt slackened.
- Dust and scales accumulated in cooling system.
- Radiator fins clogged or deformed.
- Thermostat defective.
- Radiator filler cap loosened (when operating at high altitude).
- Engine water gauge defective.

Indicator on engine water gauge is in abnormal range.

- Thermostat is defective.
- Engine water gauge is defective.

Engine fails to start.

- Insufficient fuel.
- Air entrapped in fuel supply system.
- Fuel injection pump or nozzle defective.
- Starter cannot crank engine fast enough.
- Insufficient compression.
- Incorrect valve clearance.

Exhaust is white or bluish.

- Excessive oil in oil pan.
- Improper fuel used.

Exhaust is black.

- Air cleaner element clogged.
- Nozzle defective.
- Insufficient compression.

Combustion occasionally gives stuttering sound.

- Nozzle defective.

Abnormal sound (in combustion or mechanical operation).

- Fuel of inferior quality used.
- Overheating occurs.
- Muffler broken.
- Excess valve clearance.

ELECTRICAL SYSTEM

Lamps are not bright despite maximum engine revolution.

Lamps flicker while engine is in operation.

- Electrical wiring defective.
- Belt tension out of adjustment.

Ammeter gives no deflection despite engine operation.

- Ammeter defective.
- Electrical wiring defective.

Alternator has abnormal sound.

- Alternator defective.

Starting motor fails to turn when starting switch is turned on.

- Electrical wiring defective.
- Battery charge low.

Starting motor pinion moves in and out repeatedly.

- Battery charge low.

Cranking of engine by starting motor is too slow.

- Battery charge low.
- Starting motor defective.

Starting motor slips out of engagement before start-up of engine.

- Electrical wiring defective.
- Battery charge low.

STORAGE

BEFORE STORAGE

To place the machine in storage for an extended period of time, the following measures must be taken to insure that it can be returned to operation with minimum of service.

- After every part is washed and dried, the machine shall be housed in a dry building. Never leave it outdoors.

In case it is indispensable to leave it outdoors, lay wood plates on the ground, and park the machine on the wood plates and cover it with canvas etc.

- Completely fill fuel tank, lubricate and change oil before storage.

- Apply a thin coat of grease to metal surface (hydraulic piston rods and front idler adjusting rods).

- As to batteries, remove the terminals and cover them, or remove them from the machine and store separately.

- When the ambient temperature is anticipated to drop below 0°C, always add antifreeze in the cooling water.

DURING STORAGE

- Operate the engine and move the machine for a short distance once a month so that new oil film will be coated over movable parts and component surfaces.

- Before operating the working equipment, wipe off the grease on the hydraulic piston rod.



If it is unavoidably necessary to carry out rust-preventive operation while the machine is indoors, open up doors and windows to improve ventilation and prevent the gas poisoning.

AFTER STORAGE

After storage (when it is kept without cover or the rust-preventive operation once a month is not made), you shall apply the following treatment before operation.

- Loosen the drain plugs on oil pan and other cases and drain mixed water.
- You should request Komatsu distributor for following service.
 - Remove the cylinder head cover and lubricate sufficiently valves and rocker arms. And inspect the valve operation.
 - Remove the inlet port of the fuel injection pump, pour 0.5 to 1ℓ of the engine oil, and tighten it.
- Bleed the air from the fuel system.
- Change engine oil pan oil.
- Replace all filters.
- Clean cooling system.
- After the engine is started, operate it until it is warmed up completely.
- ★ If the machine is stored for more than a year without carrying out the monthly rust prevention operation, contact your distributor to have the engine overhauled.

FUEL, COOLANT AND LUBRICANT

RESERVOIR	KIND OF FLUID	AMBIENT TEMPERATURE		CAPACITY (ℓ)					
		-4 -20	14 -10	32 0	50 10	68 20	86°F 30°C	Specified amount	Refill capacity
Engine oil pan	Engine oil							MST-300 : 8.0	7.0
								MST-500 : 9.0	7.5
								MST-600 : 7.0	6.0
								MST-800 : 7.0	6.0
								MST-1100:12.5	10.5
								MST-1500:20.0	18.0
Hydraulic tank	Hydraulic oil							MST-300 : 53	50
								MST-500 : 53	50
								MST-600 : 53	50
								MST-800 : 73	70
								MST-1100:73	70
								MST-1500:74	70
Fuel tank	Diesel fuel							MST-300 : 60	—
								MST-500 : 60	—
								MST-600 : 60	—
								MST-800 : 80	—
								MST-1100:80	—
								MST-1500:120	—
Cooling system	Water							MST-300 : 8.5	—
								MST-500 : 9.0	—
								MST-600 : 13.5	—
								MST-800 : 13.5	—
								MST-1100:21.0	—
								MST-1500:21.0	—

ASTM: American Society of Testing and Material
 SAE: Society of Automotive Engineers
 API: American Petroleum Institute

Specified capacity: Total amount of oil including oil for components and oil in piping.

Refill capacity: Amount of oil needed to refill system during normal inspection and maintenance.

NOTE:

(1) When fuel sulphur content is less than 0.5%, change oil in the oil pan every periodic maintenance hours described in this manual.

Change oil according to the following table if fuel sulphur content is above 0.5%.

Fuel sulphur content	Change interval of oil in engine oil pan
0.5 to 1.0%	1/2 of regular interval
Above 1.0%	1/4 of regular interval

- (2) When starting the engine in an atmospheric temperature of lower than 0°C, be sure to use engine oil of SAE10W and SAE10W-30, even though an atmospheric temperature goes up to 10°C more or less in the day time.
- (3) Use API classification CD as engine oil and if API classification CC, reduce the engine oil change interval to half.

FUEL, COOLANT AND LUBRICANTS

No.	Supplier Name	Engine Oil [CD] SAE10W, SAE30, SAE10W/30, SAE15W/40	Gear Oil [GL-4, GL-5] SAE90, SAE140,	Grease [Lithium-Base] NLGI-2	Anti-Freeze Coolant [Ethylene Glycol Base] [Permanent Type]
1	AGIP	Diesel Sigma S Superdiesel Multigrade	ROTRA MP	GR M	—
2	AMOCO	Amoco 300	Multi-Purpose Gear	Super Permalube Grease	—
3	ARCO	Arco Fleet S-3 Plus	HD Gear Oil	Litholine H-EP	—
4	BP	Vanellus C-3	Hypoidgear EP Gear Oil EP	Energrease L2 Energrease L.S2	Antifreeze
5	CALTEX	RPM Delo 300 RPM Delo 400	Multipurpose Thuban EP Universal Thuban	Marfak Multipurpose Marfak All Purpose	AF Engine Coolant
6	CASTROL	RX Super CRD	Hypoy, Hipress Hypoy B, Hypoy C	LM Grease	Antifreeze
7	CHEVRON	Delo 300 Delo 400	Universal Gear	Multi-Motive Grease Ultra-Duty Grease 2	—
8	ELF	Multiperformance 3C Performance 3C	Tranself EP T-anself EP Type B	Multi EPEXA 2	Glacelf
9	EXXON (ESSO)	Essolube D-3 Essolube XD-3 Essolube XD-3 Extra	Gear Oil GP Gear Oil GX	Multi Purpose Grease Beacon EP2	—

No.	Supplier Name	Engine Oil [CD] SAE10W, SAE30, SAE10W/30, SAE15W/40	Gear Oil [GL-4, GL-5] SAE90, SAE140,	Grease [Lithium-Base] NLGI-2	Anti-Freeze Coolant [Ethylene Glycol Base] [Permanent Type]
10	GULF	Super Duty	Multi-Purpose Gear Hypoid Gear All Purpose Type	Gulfcrown Grease No. 2 Gulfcrown EP Special Grease No. 2	Cruisemaster Antifreeze and Summer Coolant
11	MOBIL	Delvac 1300 Delvac 1400 Delvac 1400 Super	Mobilube HD Mobilube GX	Mobilgrease MP Mobilgrease 77 Mobilgrease 532 Mobilux EP2	Permazone
12	PENNZOIL	Supreme Duty Fleet Multi-Duty	No.4092 Multi-Purpose Gear No.4096 No.4140	Multi-Purpose No. 705 Wheel Bearing No.707L	Anti Freeze & Summer Coolant
13	SHELL	Rimula Rimula X	Spirax EP Spirax Heavy Duty	Alvania Grease EP	—
14	SUN	Sunfleet Dieselube XL Sunfleet Super C	Sunfleet GL-5	Sunfleet HP Sun Prestige 742 EP	Sunoco Multi-Season Anti-Freeze
15	TEXACO	Ursa Super Plus Ursa Oil LA Ursa Super LA	Multigear Lubricant EP Thuban	Marfak All Purpose Marfak Multi Purpose 2	Startex AF & Summer Coolant
16	TOTAL	Rubia S Rubia x	TOTAL EP Transmission TM	Multis EP2	Antifreeze
17	UNION	Guardol	MP Gear Lube LS	Unoba EP	—

HYDRAULIC OIL (CONFORMING TO ISO)

Supplier Name	Tropical region	Temperate region	Arctic region
Idemitsu	Daphne Super Hydraulic Fluid 56	Daphne Hydraulic Fluid 32	Daphne Hydraulic Fluid 18AV
Kyodo	Hydlux 68	Hydlux 32	Hydro W32
Pentalube	Penta HR-56	Penta HR-32	Penta HR-22
Esso	Teresso 68	Teresso 32	Nuto H15
Shell	Tellus oil 56	Tellus oil 32	Tellus oil T37
Mobil	D.T.E. Heavy Medium	D.T.E. Light	D.T.E. 13